

Precedent Gas/Electric/Cooling Only Packaged Rooftop

Unit Overview - YSJ102A4SOH**00

Application	Unit Size	Supply Fan		External Dimensions (in.)			Operating Weight	EER	IEER/SEER	Elevation
DX Cooling / Gas Heat	8.5 Ton	Airflow	Total External Static Pressure	Height	Width	Length	1026.0 lb	11.00	14.60	0.00 ft
		3400 cfm	0.600 in H2O	4.24 ft	4.44 ft	7.34 ft				

Unit Electrical

Voltage/phase/hertz	460/60/3
MCA	25.00 A
MOP	30.00 A
Condenser Fan FLA	1.50 A
Evaporator Fan FLA	4.60 A
Compressor 1 RLA	9.90 A
Compressor 2 RLA	5.80 A
Compressor Power	7.27 kW
System Power	9.73 kW



Controls

Unit Controls Symbio 700

Cooling Section

		Capacity
Entering Dry Bulb	80.00 F	Gross Total 105.97 MBh
Entering Wet Bulb	67.00 F	Gross Latent 24.48 MBh
Ambient Temp	95.00 F	Gross Sensible 81.49 MBh
Leaving Coil Dry Bulb	57.54 F	Net Total 102.62 MBh
Leaving Coil Wet Bulb	56.78 F	Net Sensible 78.14 MBh
Leaving Unit Dry Bulb	59.19 F	Net Sensible Heat Ratio 76.15 %
Leaving Unit Wet Bulb	57.44 F	Fan Motor Heat 0.56 MBh
Saturated Discharge Temperature	118.23 F	Refrig Charge-Circuit 1 9.5 lb
Saturated Suction Temperature	51.75 F	

Heating Section

Heating	High Gas Heat
Input Heating Capacity	200.00 MBh
Output Heating Capacity	162.00 MBh
Heating EAT	60.00 F
Heating LAT	103.47 F
Heating Temp Rise	43.47 F

Fan Section

Indoor Fan Data		Indoor Fan Performance	
Airflow Application	Downflow	Airflow	3400 cfm
Design ESP	0.05 ft H2O	Supply Motor Horsepower	3.100 hp
Component SP	0.000 in H2O	Indoor Motor Operating Power	1.030 hp
Heat SP	0.000 in H2O	Indoor RPM	1157 rpm
Total External SP	0.600 in H2O	Outdoor Fan Data	
Supply Fan Count	1.00 Number	Outdoor Fan Drive Type	Direct
Indoor Fan Drive Type	Variable Direct	Outdoor Fan Quantity	1.00 Number
Indoor Fan Quantity	1.00 Number	Outdoor Fan Type	Propeller
Indoor Fan Type	BC Plenum		

Acoustics

Sound Path	63 Hz	125 Hz	250 Hz	500 Hz	1 kHz	2 kHz	4 kHz	8 kHz
Ducted Discharge	80 dB	74 dB	74 dB	67 dB	62 dB	59 dB	58 dB	58 dB
Ducted Inlet	77 dB	68 dB	68 dB	59 dB	54 dB	51 dB	50 dB	49 dB
Outdoor Noise	85 dB	84 dB	91 dB	92 dB	89 dB	84 dB	80 dB	74 dB

Note:Ducted Discharge and Ducted Inlet Sound in accordance with AHRI 260-2017

Note:Outdoor Sound in accordance with AHRI 270-2015

NOTES:
1. VERIFY WEIGHT, CONNECTION, AND ALL DIMENSION WITH INSTALLER DOCUMENTS BEFORE INSTALLATION

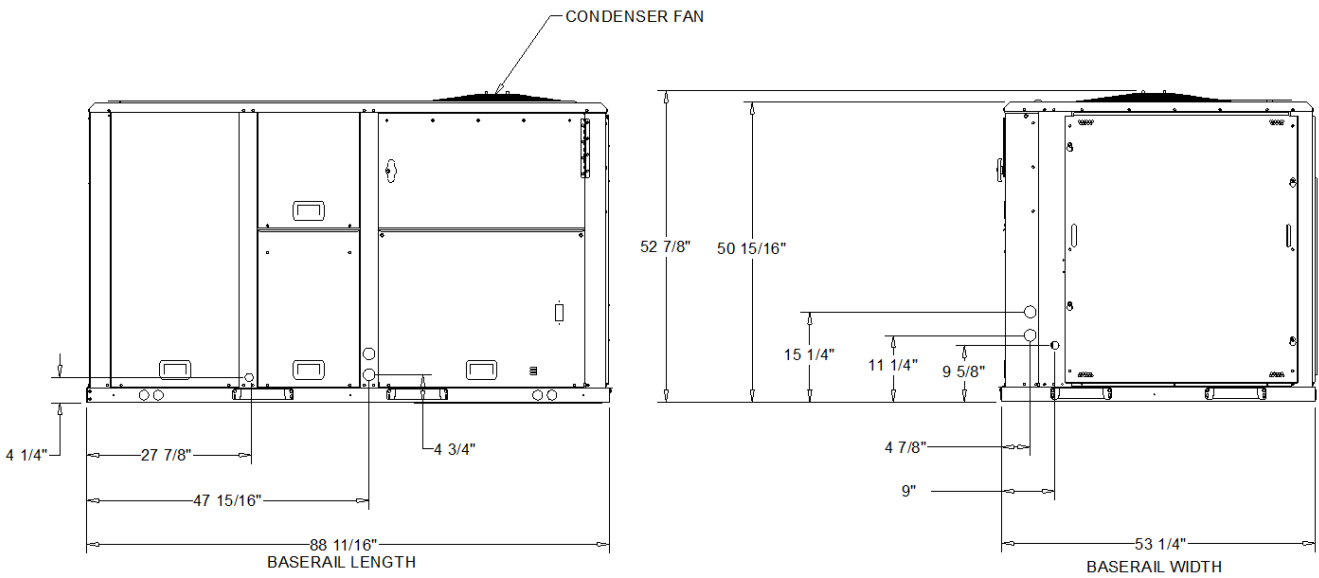
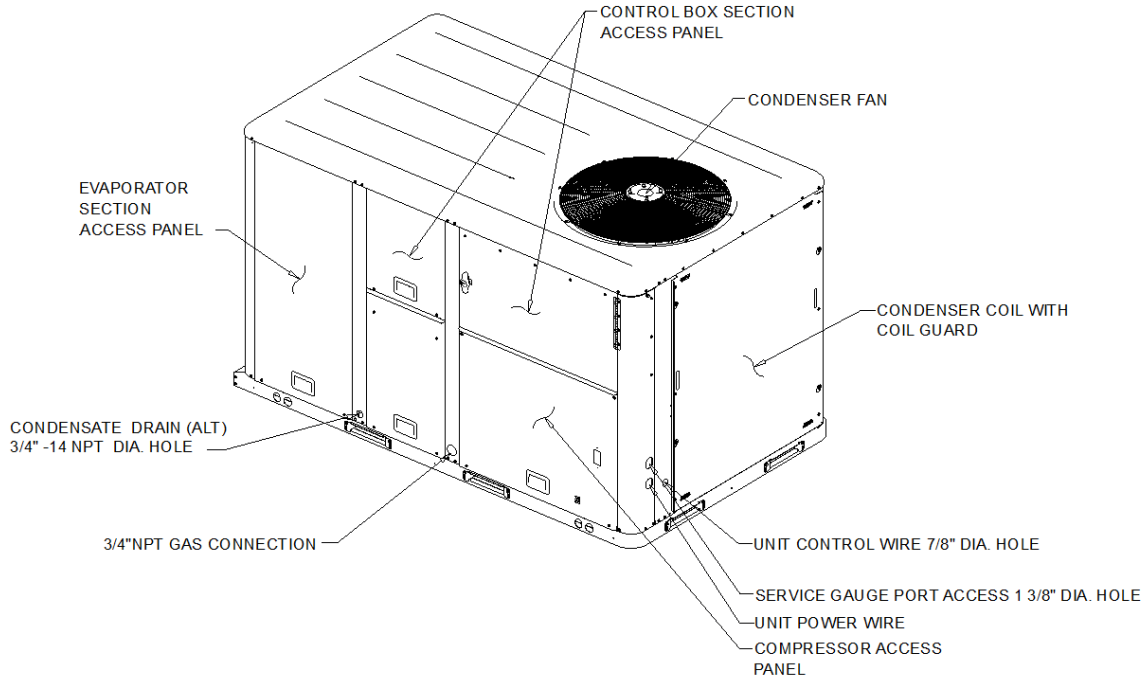

DX COOLING / GAS HEAT STANDARD EFFICIENCY

DIMENSION DRAWING

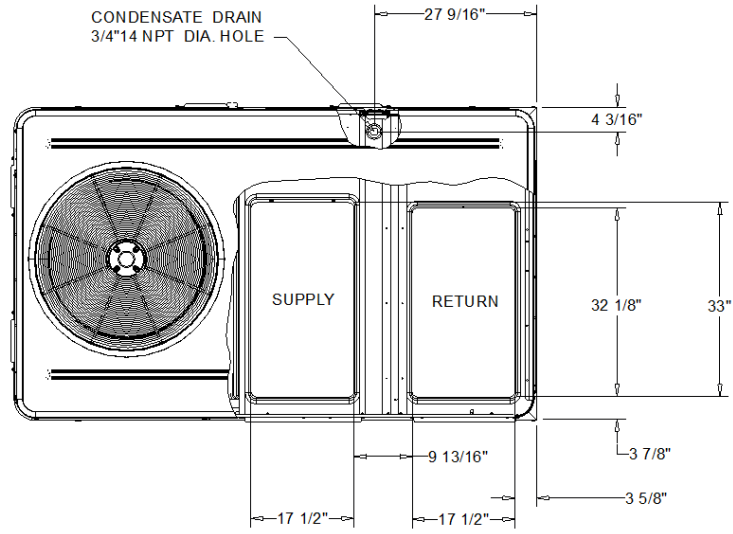

PLAN VIEW OF DOWNFLOW OPENINGS

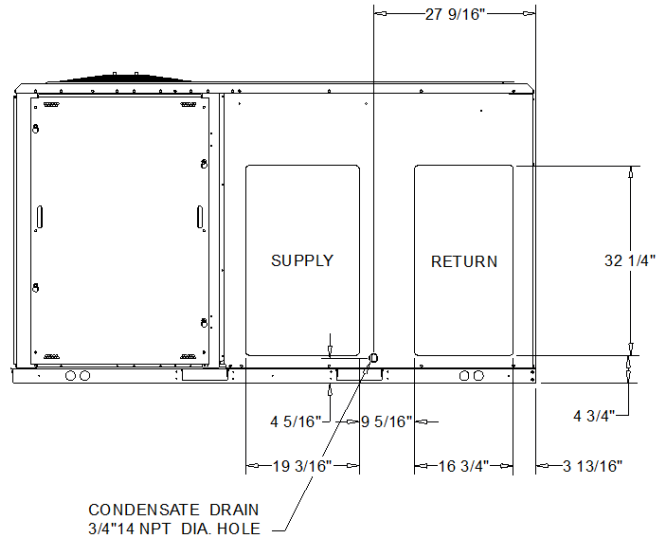

HORIZONTAL AIR FLOW OPENING

DX COOLING / GAS HEAT STANDARD EFFICIENCY

DIMENSION DRAWING

NOTES:

1. APPROX. INSTALLED WEIGHT INCLUDES ALL SELECTED OPTIONS AND ACCESSORIES.
2. CORNER WEIGHTS ARE FOR BASE UNIT ONLY AND DO NOT INCLUDE OPTIONS OR ACCESSORIES.
3. WEIGHT INCLUDES BOTH FACTORY AND FIELD INSTALLED ACCESSORY.

Approximate Installed Weight: 1,026.0 lb

(B) Corner Weight: 345.0 lb

(C) Corner Weight: 199.0 lb

(A) Corner Weight: 370.0 lb

(D) Corner Weight: 213.0 lb

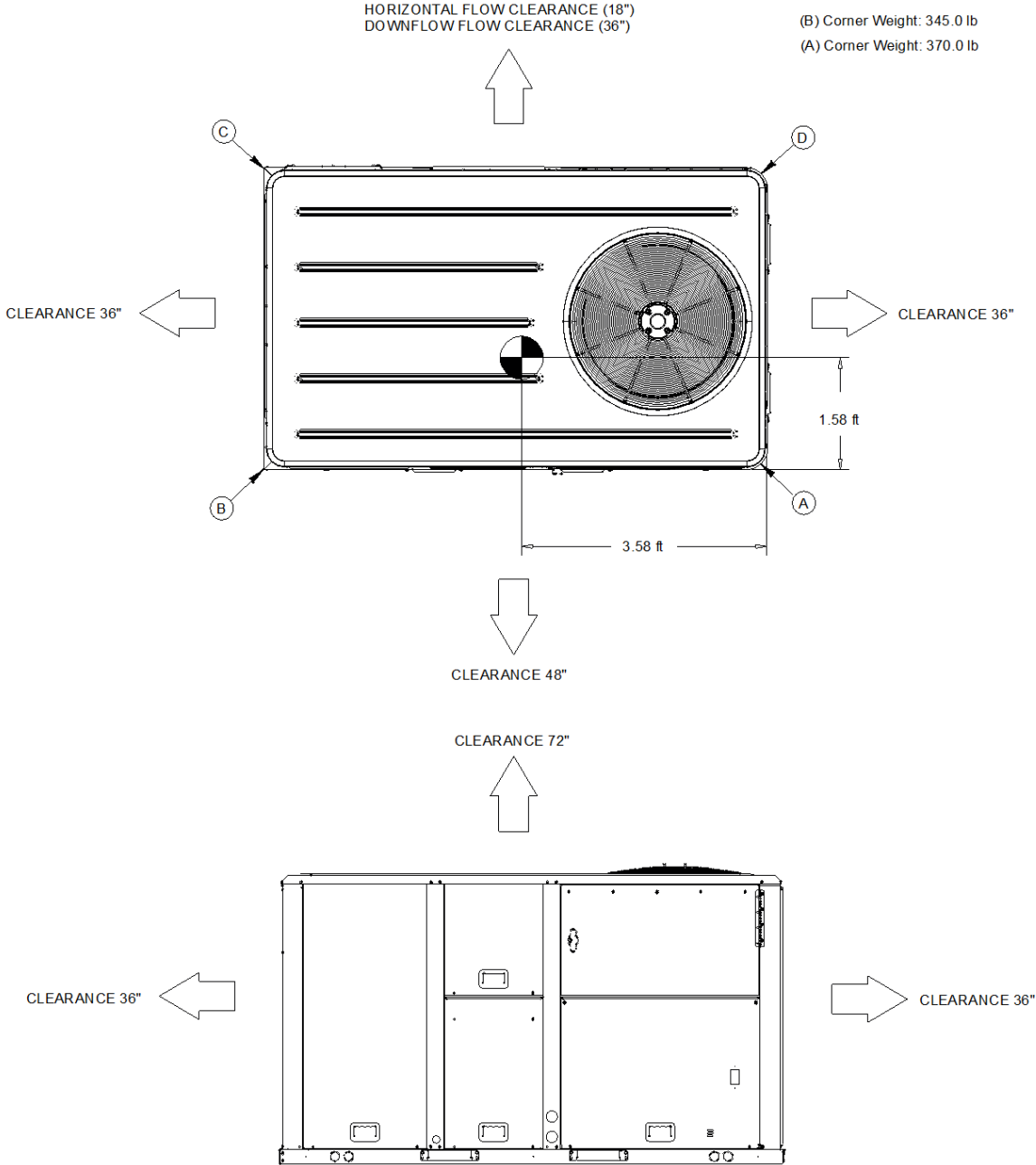

DX COOLING / GAS HEAT STANDARD EFFICIENCY

WEIGHTS AND CLEARANCES

General

- Packaged rooftop units cooling, heating capacities, and efficiencies are AHRI Certified within scope of AHRI Standard 210-240 for 6 to 25 Tons and ANSIZ21.47 and 10 CFR Part 431 pertaining to Commercial Warm Air Furnaces (all gas heating units).
- Convertible airflow.
- Symbio controls operating range is from 0-125.0 F from factory; if designing for cooling mode operation below 40.0 F ambient temp, add low ambient kit to assure continuous and reliable operation.
- Factory assembled, internally wired, fully charged with R-410A, and 100 percent run tested to check cooling operation, fan and blower rotation, and control sequence before leaving the factory.
- Colored and numbered wiring internal to the unit for simplified identification.
- Units cULus listed and labeled, classified in accordance for Central Cooling Air Conditioners.

Casing

- Zinc coated, heavy gauge, galvanized steel.
- Weather resistant pre-painted metal with galvanized substrate.
- Meets ASTM B117, 672 hour salt spray test.
- Removable single side maintenance access panels.
- Lifting handles in maintenance access panels (can be removed and reinstalled by removing fasteners while providing a water and air tight seal).
- Exposed vertical panels and top covers in the indoor air section insulated with a cleanable foil-faced, fire-retardant permanent, odorless glass fiber material.
- Base pan shall have no penetrations within the perimeter of the curb other than the raised 1 inch high downflow supply/return openings to provide an added water integrity precaution, if the condensate drain backs up.
- Base of the unit insulated with 1/8 inch, foil-faced, closed-cell insulation.
- Unit base provisions for forklift and/or crane lifting on three sides of unit.

Hail Guards

- Provides condenser coil protection.

Microchannel Coils

- Optimal heat transfer performance due to flat, streamlined tubes with small ports, and metallurgical tube-to-fin bond.
- Reduce system refrigerant charge by up to 50% leading to better compressor reliability.
- Compact all-aluminum microchannel coils reduce the unit weight.
- Recyclable all aluminum coils All aluminium construction minimizes galvanic corrosion.
- Strong aluminum brazed structure provides better fin protection.
- Flat streamlined tubes more dust resistant and easy to clean.
- Coils leak tested at the factory to ensure the pressure integrity.

Compressors

- All units have direct-drive, hermetic, scroll type compressors with centrifugal type oil pumps.
- Suction gas-cooled motor with voltage utilization range of plus or minus 10 percent of unit nameplate voltage.
- Internal overloads standard with scroll compressors.
- Crankcase heaters are standard on all compressors.
- All units have dual compressors.
- Three stages of cooling available on 6 to 17.5 tons units and four stages of cooling available on 20 and 25 tons units.

Filters

- Two inch standard filters shall be factory supplied on all units.

Frostat

- Utilized as a safety device.
- Opens to prevent freezing temperatures on evaporator coil.
- Temperature will need to rise to 50°F before closing.
- Utilized in low airflow or high outside air applications (cooling only).

Gas Heating Section

- The heating section shall have a progressive tubular heat exchanger with corrosion-resistant aluminized steel tubes and burners as standard on all models.
- Stainless steel heat exchanger with 409 stainless steel tubes and 439 stainless steel burners shall be optional.
- Induced draft combustion blower shall be used to pull the combustion products through the firing tubes.
- Heater shall use a direct spark ignition (DSI) system.
- On initial call for heat, the combustion blower shall purge the heat exchanger for 20 seconds before ignition.
- After three unsuccessful ignition attempts, entire heating system shall be locked out until manually reset at the thermostat/zone sensor.
- Units shall be suitable for use with natural gas or propane (field-installed kit).

Heat Exchanger

- Compact cabinet features a tubular heat exchanger in low, medium and high heat capacities.
- Corrosion-resistant aluminized steel tubes and burners are standard on all models.
- Induced draft blower to pull the gas mixture through the burner tubes.
- Direct spark ignition and a flame sensor as a safety device to validate the flame.

Indoor Fan

- Direct drive plenum fan design - 6 to 25 tons units.
- Plenum fan design - backward-curved fan wheel along with an external rotor direct drive variable speed indoor motor.
- Supply fan speed adjustments can be made using the Symbio 700 or Mobile App.
- Motors are thermally protected.
- Variable speed direct drive motors are high efficiency - 6 to 25 tons.

TSJ072-120*, Downflow, Std Filter, Wet Coil, Cooling Only

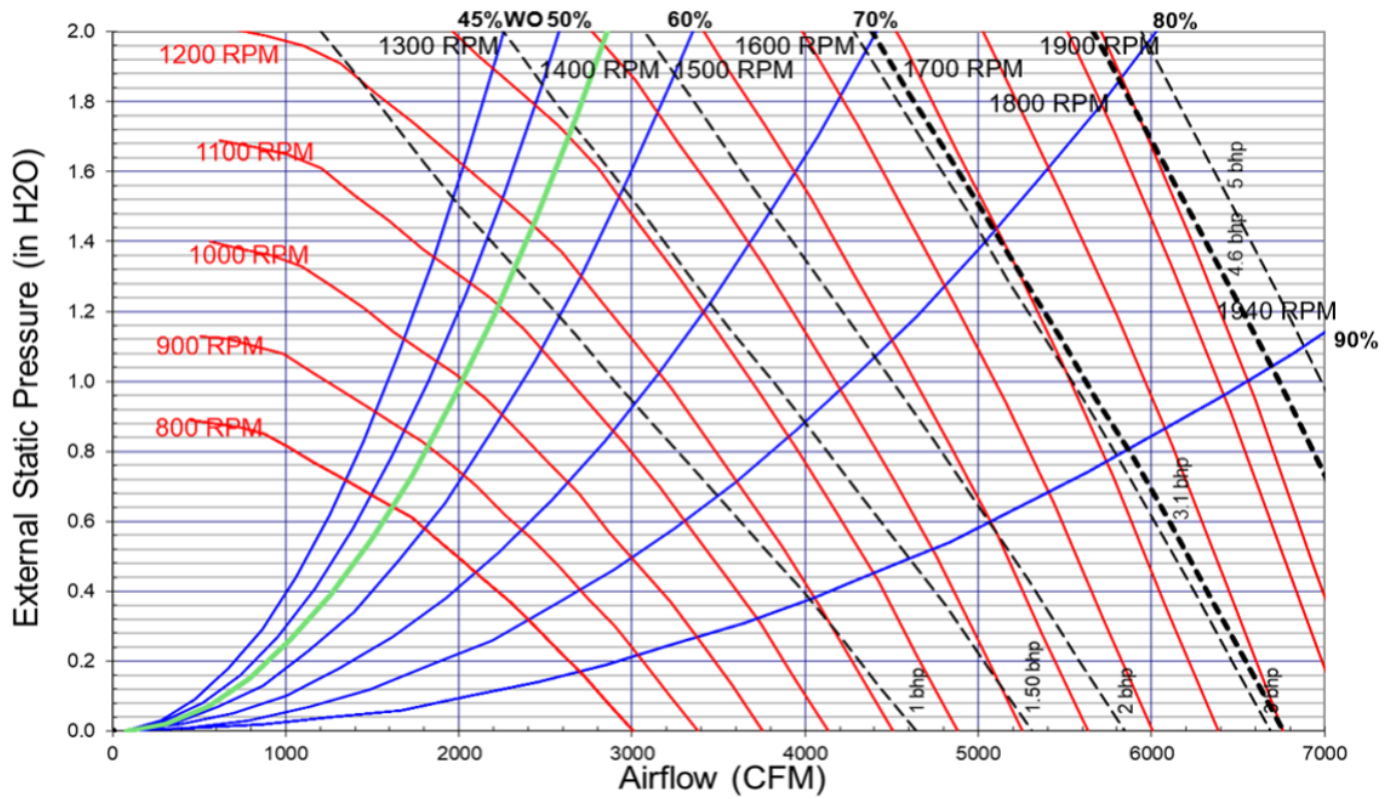

Note: Fan Curves are for TSJ/WSJ units. For YSJ units, add additional static pressure for Gas Heat Exchanger (ref. RT-PRC098*, table 47)

TSJ072-120*, Horizontal, Std Filter, Wet Coil, Cooling Only

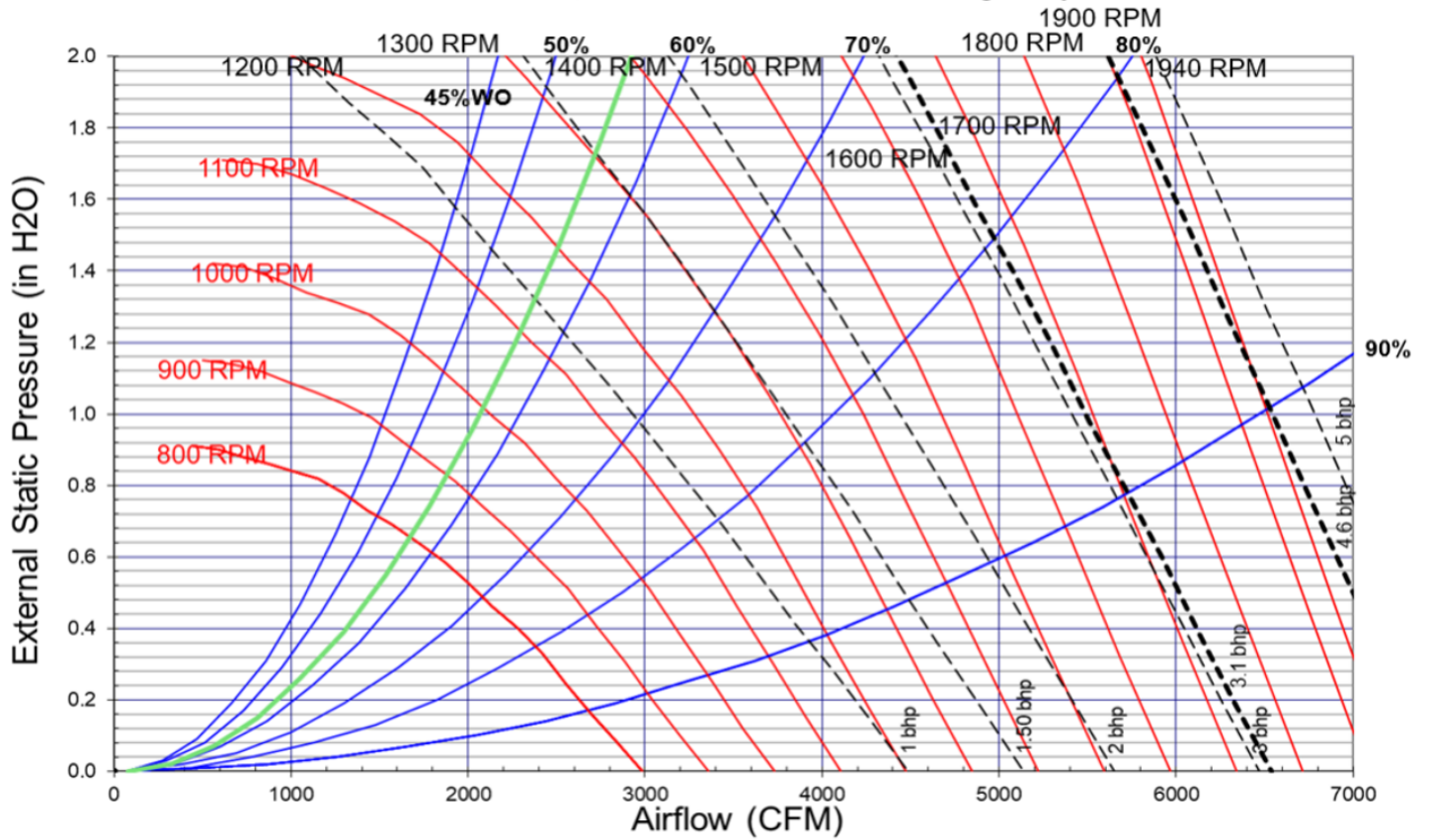

Note: Fan Curves are for TSJ/WSJ units. For YSJ units, add additional static pressure for Gas Heat Exchanger (ref. RT-PRC098*, table 47)